

# ASPIRO 2U FRONT ACCESS

MODEL Aspiro Front Access 2U (MS23)  
2U Integrated DC Power System  
-48VDC | 60A | 3.2kW

## INDUSTRIES & APPLICATIONS



## KEY FEATURES

- ◆ >95% Efficiency Rectifiers
- ◆ 60A / 3.2kW Load Capacity
- ◆ Full Front Access
- ◆ Remote Monitoring & Control
- ◆ Field Replaceable Controller
- ◆ Ethernet Comm. with SNMPv3
- ◆ 3 LED Alarm/Status Indicators
- ◆ 4 Form-C Relay Alarms
- ◆ 8 Load & 2 Battery Breakers
- ◆ Bulk Feed for External PDU
- ◆ LCD Display/Touchpad
- ◆ Easy Installation

## SAFETY COMPLIANCE

UL60950-1 2nd Ed.  
CSA22.2 No. 60950-1 2nd Ed.  
EN60950-1 2nd Ed.

## THREE YEAR WARRANTY

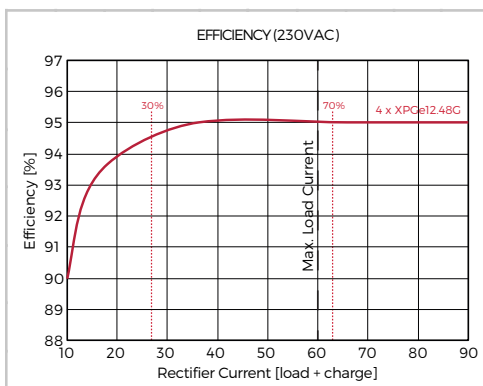

## DESCRIPTION

Aspiro 2U Front Access is a 2RU high 19" rack-mounted, integrated DC power system providing an output of -48VDC. The system can accommodate up to 4 Aspiro family high efficiency hot-swap rectifiers. A total load current of 60A / 3.2kW is available with battery charge current up to 30A in addition. The rectifiers are internally fan cooled with speed control which is a function of load and temperature, keeping acoustic noise to a minimum. The systems offers full front access for cable connections with an optional push-pull mounting bracket for either 19" or ETSI mounting.

The DC output circuits can provide up to 8 loads with breakers rated from 1A to 30A. 2 additional breakers provide battery protection. A programmable 125A low voltage battery disconnect (LVBD) is standard while a partial load disconnect (PLD), also rated at 125A and programmable, can provide non-critical load shedding when operating on batteries.

The ACC Extended remote access controller monitors system parameters, controls rectifier output, and provides alarms for system failures. The Controller Module is also pluggable for easy field replacement in case of failure. There are 2 LED alarm indicators which indicate failures, (RED) Alarm and (YELLOW) Message. A third green LED indicates the controller is working properly. As standard four form-C relay outputs provide the alarms for remote use. Two digital inputs and outputs are also provided as well as a microSD card slot that accepts an up to 4GB card which is sufficient for more than 20 years data logging.

The system can be programmed by means of a remote PC web page display. Communication is by Ethernet LAN with SNMPv3 including alarm trapping. It also has provision for temperature compensated charging of an external battery using a supplied TC probe. An LCD Display/Touchpad is included for local metering, status, and setup.

The Aspiro 2U Front Access is compatible with UNIPOWER's free [PowCom™ software](#) which offers local and remote management through an advanced Windows GUI.

## SYSTEM SPECIFICATION & CAPABILITY GUIDE

SYSTEM DESIGNATION	ASPIRO 2U FRONT ACCESS - 1-MS0023G	
<b>OUTPUT</b>		
System Voltage	-48VDC nominal   53.5V float	
Maximum Capacity @ 120VAC nominal	Load	60A
	Battery	60A discharge   30A charge (s/w controlled)
Maximum Capacity @ 230/400VAC nominal	Load	60A
	Battery	60A discharge   30A charge (s/w controlled)
No. Rectifier Slots	4	
<b>DC DISTRIBUTION</b>		
Loads Circuits	8 x 1A to 30A (see configuration guide on page 6)	
Bulk Feed for External PDU Connection	1 x 60A	
Battery Circuits	2 x 30A to 100A (see configuration guide on page 6)	
<b>INPUT</b>		
Voltage (nominal)	1-phase 100-120/200-240VAC (L + N + PE) 3-phase 230/400VAC (L1 L2 L3 + N + PE)	
Frequency	47-63Hz	
Maximum Input Current	32A @ 100-120VAC   14A @ 200-240VAC   8A per phase @ 400/230VAC	
Rectifier Power Factor	>0.98 (typical)	
Surge Protection	Optional (see configuration guide on page 6)	
<b>MONITORING &amp; CONTROL (ACC Extended Controller)</b>		
Alarm Relays	4	
Local Interface	4 x 20 LCD, 4-key menu, USB / RS232, microSD card slot (4GB max.) for data logging	
Remote Interface	Ethernet / Modem using PowCom™ software package Ethernet port allows monitoring and control over a TCP/IP network. Web browser support + SNMPv3	
LED Indications	Green - System ON; Yellow - Message(s); Red LED - Alarm(s)	
External Digital I/O	2 x Inputs, 2 x Outputs (Open Collector)	
<b>BATTERY MANAGEMENT</b>		
Symmetry Inputs	6 or 12 (can be redefined as analog inputs up to 100VDC)	
Low Voltage Battery Disconnect (LVBD)	1 x 125A Programmable	
Partial Load Disconnect (PLD)	1 x 125A Programmable (Optional)	
Temperature Compensated Charging	Programmable	
<b>COMPLIANCE</b>		
EMC	EN 300 386 ; EN61000-6-3 (Emission) ; EN61000-6-2 (Immunity)	
Safety	IEC60950-1:2005 2 Ed. +A1:2009	
<b>ENVIRONMENTAL</b>		
Operating Temperature	-40°C to +65°C (derated above +55°C, see manual and rectifier datasheet for details)	
Storage Temperature	-40°C to +85°C	

### RECTIFIER MODULES vs. SYSTEM CAPACITIES

RECTIFIER MODULES (float voltage 53.5V)						SYSTEM CAPACITY		
MODEL NUMBER	EFFICIENCY <sup>1</sup>	INPUT VOLTAGE <sup>2</sup>	INPUT CURRENT <sup>3</sup>	OUTPUT POWER	OUTPUT CURRENT	MAX. CHARGE CURRENT	MAX. LOAD CURRENT	
							TOTAL	3+1 <sup>4</sup>
XR04.48G	>88.0%	85-275VAC	5.3A/2.5A	400W	7.5A	30.0A	30.0A	22.5A
XR08.48G	>90.0%	85-275VAC	10.5A/4.9A	800W	15.0A	30.0A	60.0A	45.0A
XPGe12.48G	>95.0%	90-180VAC	7.3A	600W	11.2A	30.0A	44.8A	33.6A
		180-275VAC	7.0A	1200W	22.4A	30.0A	60.0A	60.0A

Notes:

1. When operating at 230VAC.
2. All models will operate over the full range, automatically limiting output current/power according to the actual input voltage range applied.
3. Input currents shown are expected maximums at 85VAC/180VAC as appropriate.
4. May required reduction in maximum charge current when batteries not fully charged.

**FRONT PANEL DESCRIPTION**

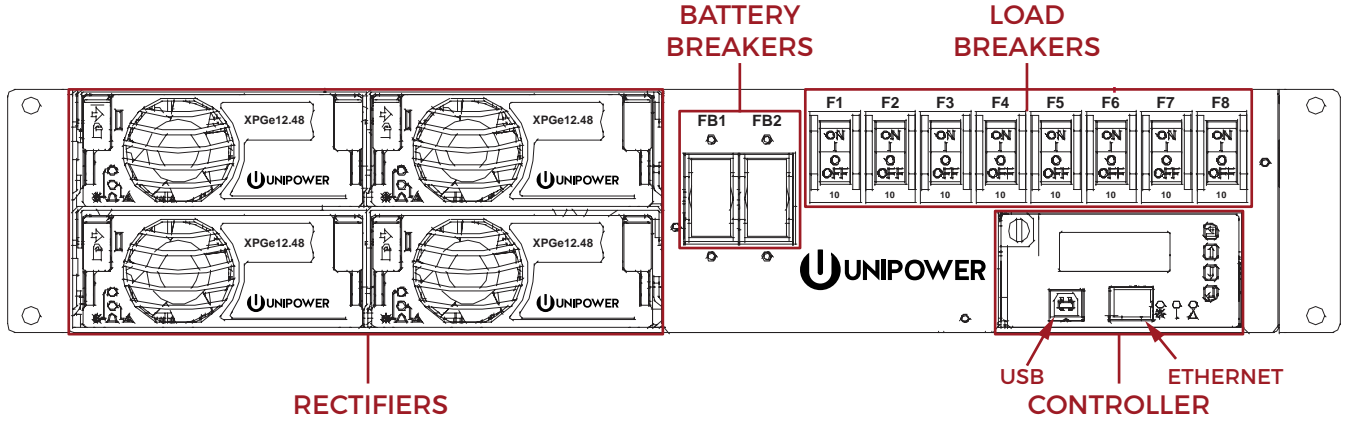

**PERSPECTIVE FRONT VIEW**

(REMOVE TOP COVER FOR ACCESS TO CONNECTIONS)

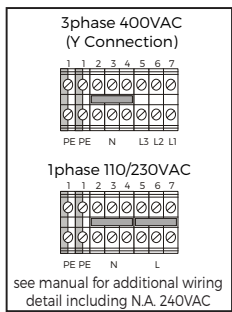
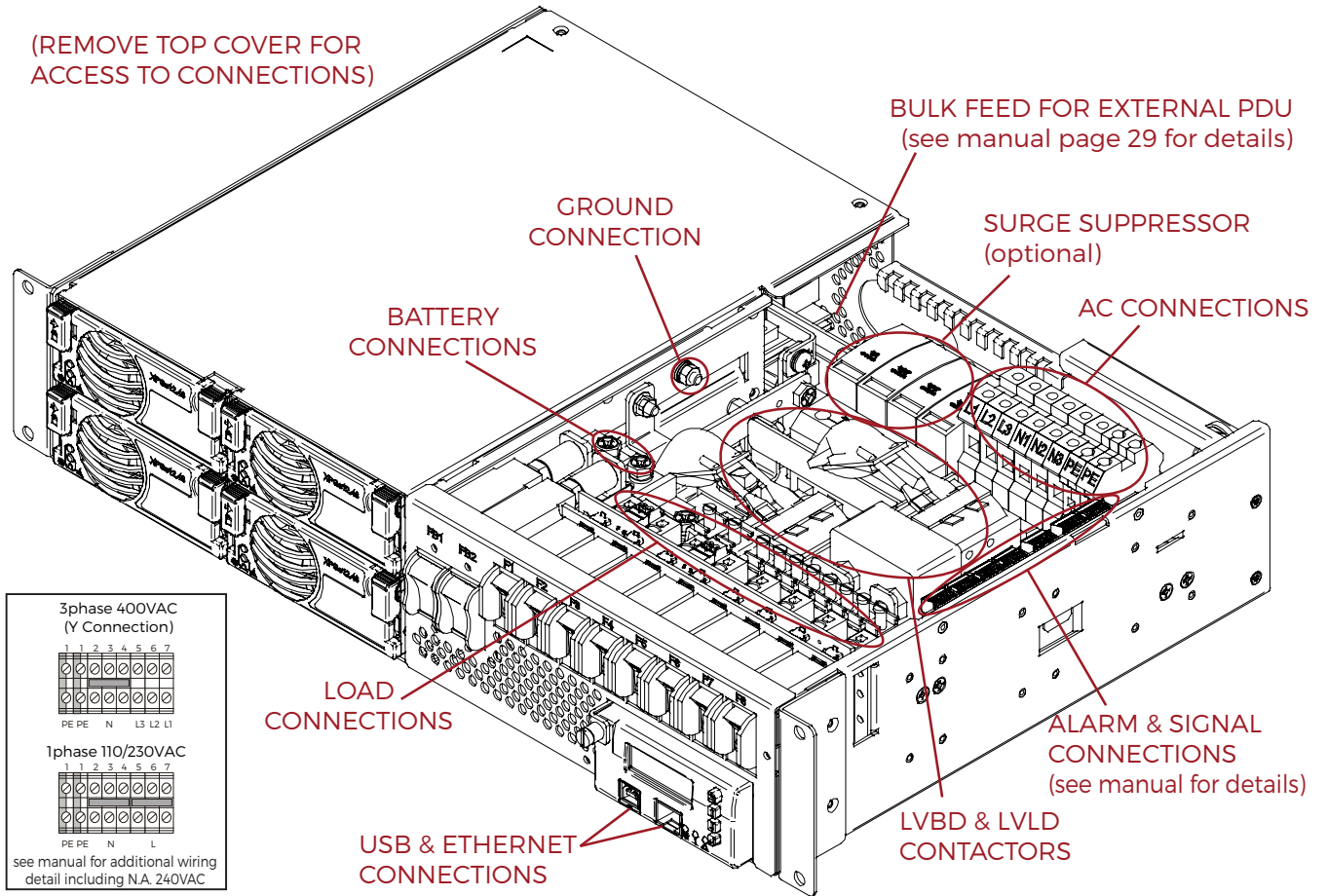

**REAR VIEW**



**CABLE ROUTING**

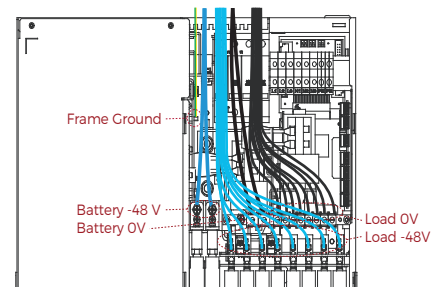
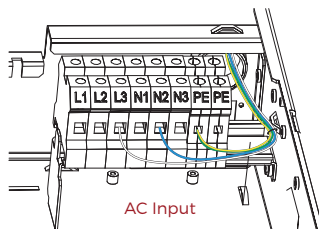

**MOUNTING BRACKET CONFIGURATIONS**

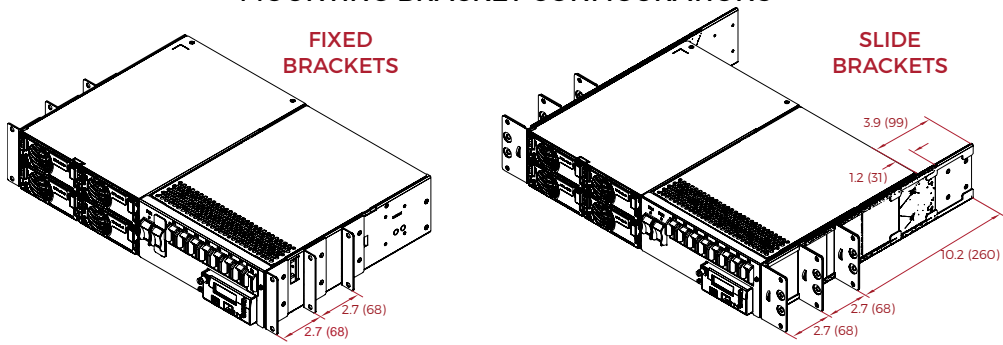

**DETAILED DIMENSIONS - FIXED BRACKET OPTION**

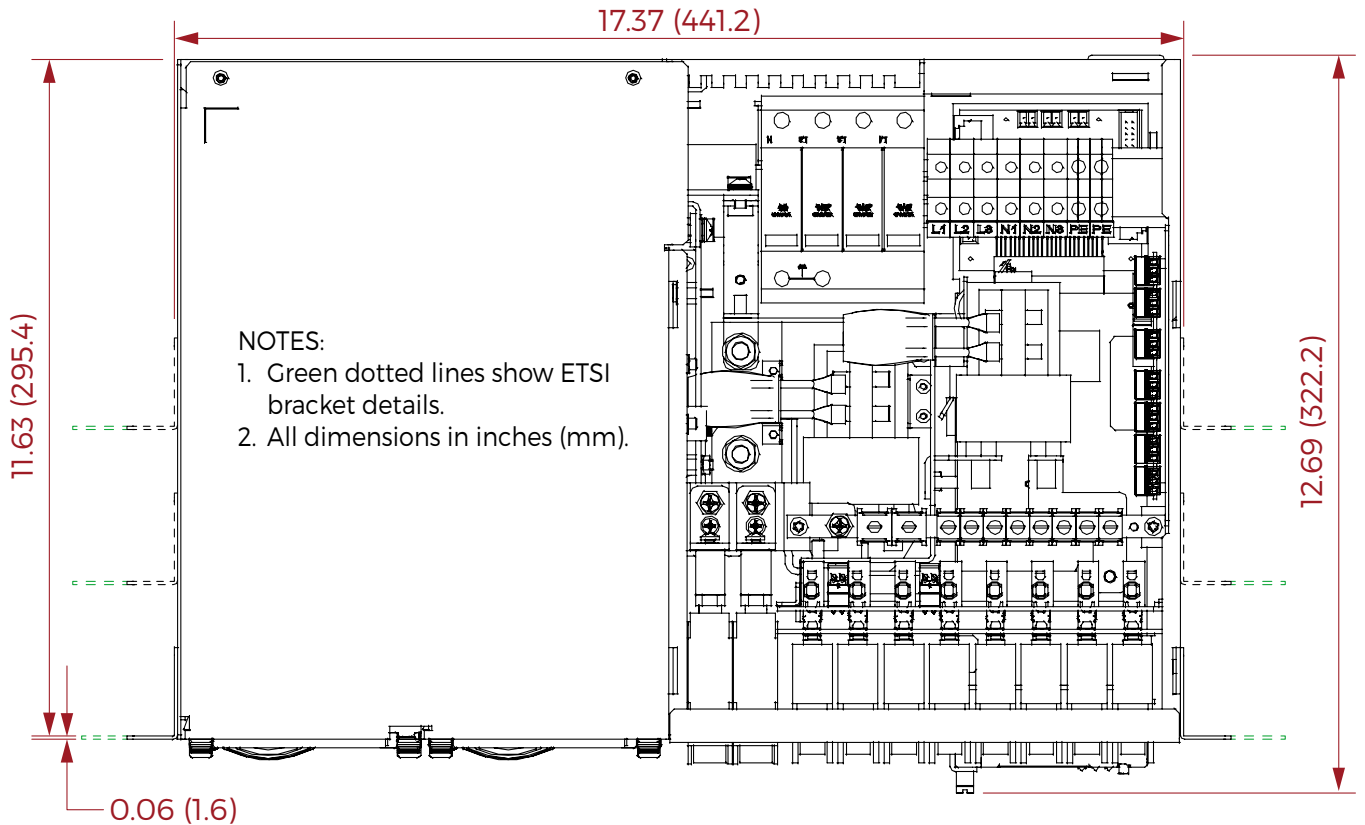
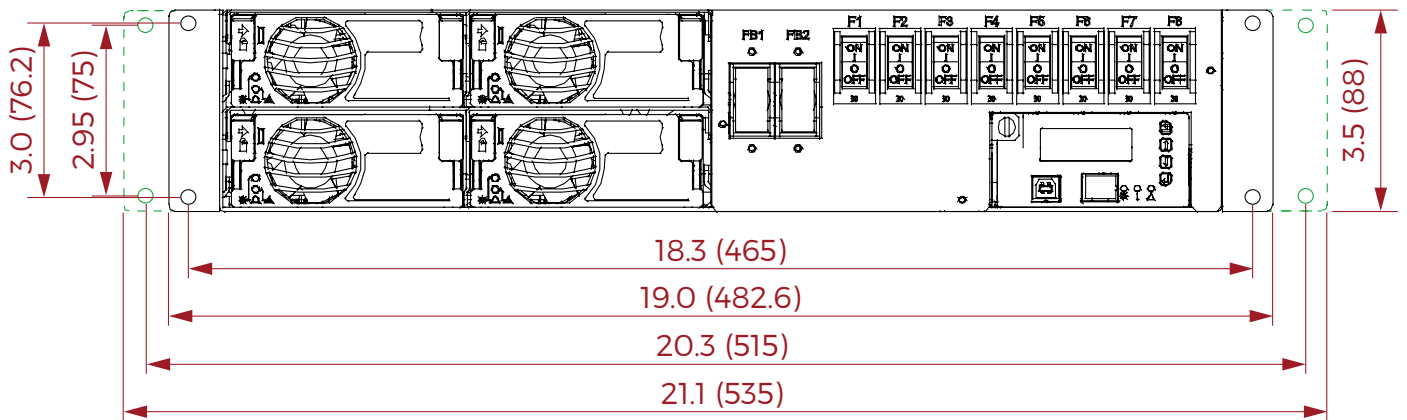

### DETAILED DIMENSIONS - SLIDE BRACKET OPTION

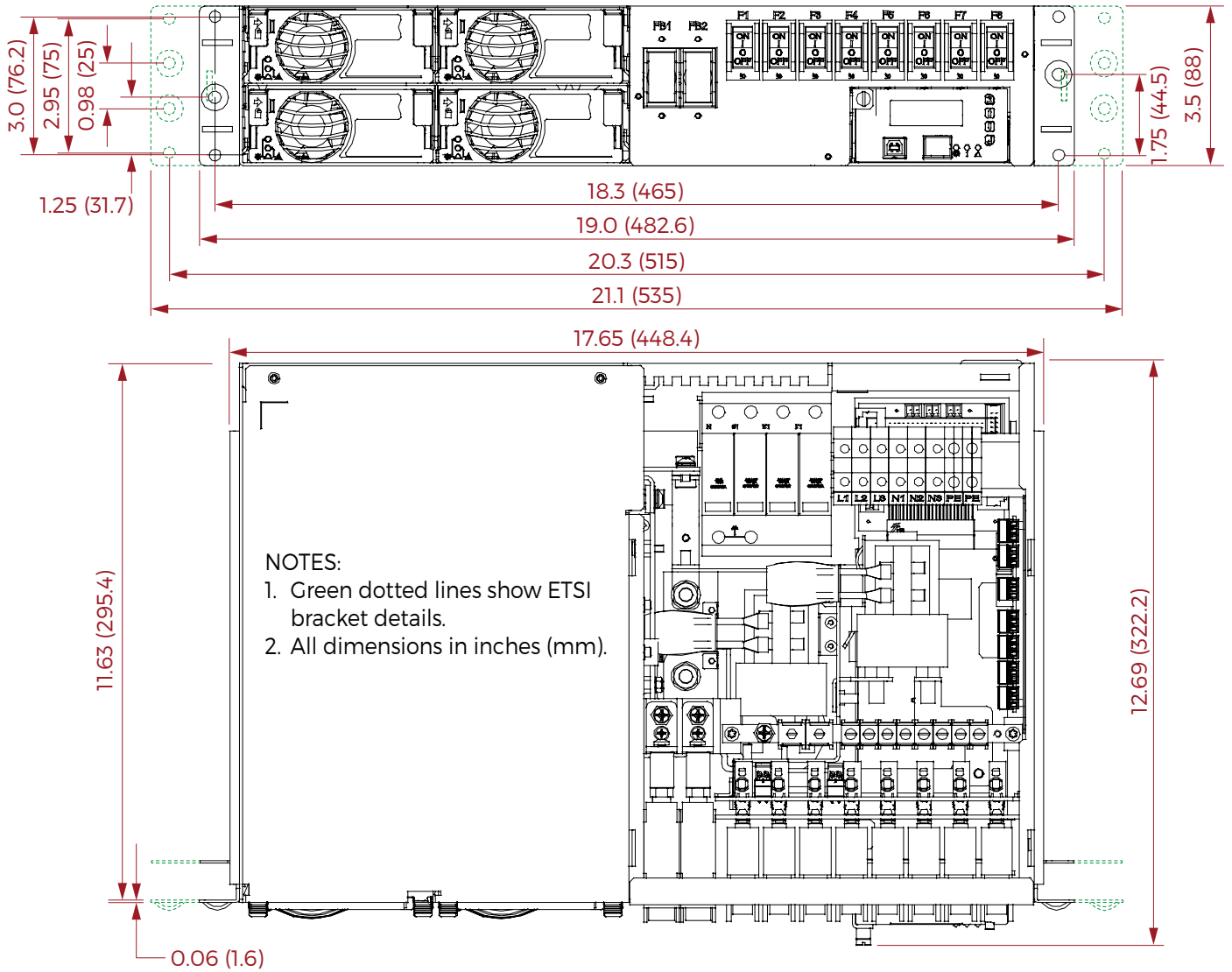

### WEIGHTS & DIMENSIONS

UNIT	UNIT				PACKAGED				
	Width	Height	Depth	Weight	Width	Height	Depth	Weight	# in box
System Unit (19" Mounting)	19.00 (482.5)	3.50 (88.0)	11.70 (297.2)	22 lbs (10 kg)	23.2 (589)	7.9 (200)	15.3 (387)	25 lbs (11.4 kg)	1
System Unit (ETSI Mounting)	21.10 (535.0)								
Rectifier Module	4.0 (102)	1.6 (41)	9.0 (229)	2.4 lbs (1.1 kg)	6.0 (152)	2.2 (55)	11.5 (291)	2.6 lbs (1.2 kg)	1

Dimensions in inches (mm)

## CONFIGURATION GUIDE

PLEASE COMPLETE THE BELOW TABLE AND SUBMIT TO UNIPOWER FOR VERIFICATION AND CONF. NO. ALLOCATION (This form is fully interactive and may be completed electronically OR it can be printed and completed by hand)																		
<b>STEP 1 - CUSTOMER DETAILS</b>																		
Company: _____ Address: _____ Zip Code: _____ Country: _____	Contact Name: _____ Email Address: _____ Telephone: _____ Quantity for quotation: _____																	
<b>STEP 2 - INPUT TYPE - Choose one version</b>																		
1-Phase (120/240V) 2W + PE (US 208V) 3-Phase (400V Y connection - 230V L to N each phase)	1-phase OR 2W + PE OR 3-phase																	
<b>STEP 3 - RECTIFIER MODULES - Choose one type only and enter quantity between 1 and 4 - dummies will be inserted into unused slots</b>																		
XR04.48G - 400W / 9.1A - >88% Efficiency XR08.48G - 800W / 18.2A - >90% Efficiency XPGe12.48G - 1200W / 22.6A - >95% Efficiency	<table style="width: 100%; border-collapse: collapse;"> <tr> <td style="text-align: center;">Qty 1</td> <td style="text-align: center;">OR Qty 2</td> <td style="text-align: center;">OR Qty 3</td> <td style="text-align: center;">OR Qty 4</td> </tr> <tr> <td style="text-align: center;">OR Qty 1</td> <td style="text-align: center;">OR Qty 2</td> <td style="text-align: center;">OR Qty 3</td> <td style="text-align: center;">OR Qty 4</td> </tr> <tr> <td style="text-align: center;">OR Qty 1</td> <td style="text-align: center;">OR Qty 2</td> <td style="text-align: center;">OR Qty 3</td> <td style="text-align: center;">OR Qty 4</td> </tr> </table>		Qty 1	OR Qty 2	OR Qty 3	OR Qty 4	OR Qty 1	OR Qty 2	OR Qty 3	OR Qty 4	OR Qty 1	OR Qty 2	OR Qty 3	OR Qty 4				
Qty 1	OR Qty 2	OR Qty 3	OR Qty 4															
OR Qty 1	OR Qty 2	OR Qty 3	OR Qty 4															
OR Qty 1	OR Qty 2	OR Qty 3	OR Qty 4															
<b>STEP 4 - BATTERY BREAKERS - Choose rating and quantity or NONE (Breakers MUST be identical rating)</b>																		
No Breakers (Not recommended) OR 30A x1 or x2 OR 45A x1 or x2 OR 60A x1 or x2 OR 80A x1 or x2 OR 100A x1 or x2	None OR Qty 1    OR Qty 2 OR Qty 1    OR Qty 2 OR Qty 1    OR Qty 2 OR Qty 1    OR Qty 2 OR Qty 1    OR Qty 2																	
<b>STEP 5 - PARTIAL LOAD DISCONNECT (PLD) - Select YES or NO (default)</b>																		
125A PLD (partial load / load shed disconnect)	YES    OR NO																	
<b>STEP 6 - LOAD BREAKERS - Choose quantity for desired ratings - maximum 8 positions in total. Positions not filled will have a blank fitted. When the PLD option is not selected populate only the LVBD 'critical' circuits column. [Configuration will be checked by UNIPOWER]</b>																		
	<b>LVBD CIRCUITS (Critical)</b>	<b>PLD CIRCUITS (non Critical)</b>																
1A single pole	Quantity ____ (8 max. or 7 with PLD)	Quantity ____ (1 to 7 max.)																
4A single pole	Quantity ____ (8 max. or 7 with PLD)	Quantity ____ (1 to 7 max.)																
5A single pole	Quantity ____ (8 max. or 7 with PLD)	Quantity ____ (1 to 7 max.)																
7.5A single pole	Quantity ____ (8 max. or 7 with PLD)	Quantity ____ (1 to 7 max.)																
10A single pole	Quantity ____ (8 max. or 7 with PLD)	Quantity ____ (1 to 7 max.)																
15A single pole	Quantity ____ (8 max. or 7 with PLD)	Quantity ____ (1 to 7 max.)																
20A single pole	Quantity ____ (8 max. or 7 with PLD)	Quantity ____ (1 to 7 max.)																
25A single pole	Quantity ____ (8 max. or 7 with PLD)	Quantity ____ (1 to 7 max.)																
30A single pole	Quantity ____ (8 max. or 7 with PLD)	Quantity ____ (1 to 7 max.)																
<b>STEP 7 - TEMPERATURE SENSOR - available for battery and ambient temperature measurement</b>																		
Battery Temperature Sensor - 3.0m (-10ft) Ambient Temperature Sensor - 3.0m (-10ft)	NONE    OR 3m (-10ft) NONE    OR 3m (-10ft)																	
<b>STEP 8 - SYMMETRY CABLES (Choose one type only - NONE OR 1 OR 3 with single battery OR 2 OR 4 with two battery breakers)</b>																		
3.0m (-10ft) - end measure OR 6.0m (-20ft) - end measure OR 2.3m (-7.2ft) - mid measure OR 6.0m (-20ft) - mid measure	NONE <table style="width: 100%; border-collapse: collapse;"> <tr> <td style="text-align: center;">Qty 1</td> <td style="text-align: center;">Qty 2</td> <td style="text-align: center;">Qty 3</td> <td style="text-align: center;">Qty 4</td> </tr> <tr> <td style="text-align: center;">Qty 1</td> <td style="text-align: center;">Qty 2</td> <td style="text-align: center;">Qty 3</td> <td style="text-align: center;">Qty 4</td> </tr> <tr> <td style="text-align: center;">Qty 1</td> <td style="text-align: center;">Qty 2</td> <td style="text-align: center;">Qty 3</td> <td style="text-align: center;">Qty 4</td> </tr> <tr> <td style="text-align: center;">Qty 1</td> <td style="text-align: center;">Qty 2</td> <td style="text-align: center;">Qty 3</td> <td style="text-align: center;">Qty 4</td> </tr> </table>		Qty 1	Qty 2	Qty 3	Qty 4	Qty 1	Qty 2	Qty 3	Qty 4	Qty 1	Qty 2	Qty 3	Qty 4	Qty 1	Qty 2	Qty 3	Qty 4
Qty 1	Qty 2	Qty 3	Qty 4															
Qty 1	Qty 2	Qty 3	Qty 4															
Qty 1	Qty 2	Qty 3	Qty 4															
Qty 1	Qty 2	Qty 3	Qty 4															
<b>STEP 9 - MOUNTING BRACKETS (Choose one type only - slide types allow front access)</b>																		
19" Fixed (allows front or mid fixed position mounting) OR ETSI Fixed (allows front or mid fixed position mounting) OR 19" Slide (allows front or mid push-pull mounting) OR ETSI Slide (allows front or mid push-pull mounting)	19" Fixed OR ETSI Fixed OR 19" Slide OR ETSI Slide																	
<b>STEP 10 - OPTIONS &amp; ACCESSORIES (Select required items)</b>																		
Surge Protection Kit (factory fit) Parallel Connection Kit (allows bulk connection to external PDU)	NONE    OR YES NONE    OR YES																	
<b>STEP 11 - SUBMIT COMPLETED FORM TO UNIPOWER FOR CHECKING AND ALLOCATION OF CONFIGURATION PART NUMBER</b>																		
<b>Configuration Part Number: 1-MS0023G_____ (leave blank for completion by UNIPOWER)</b>																		